

QUALIS

Product parameters:

Main Cabinet: 800*470*500mm

Mirror: 800*700mm

Ceramic Basin: 800*480mm

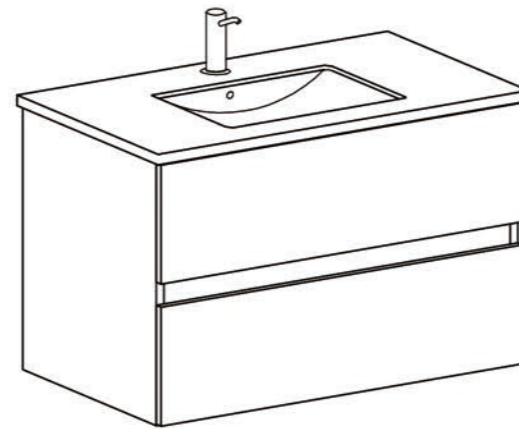
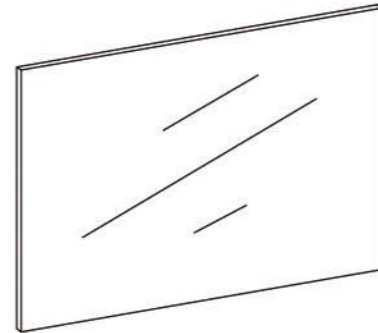

oblique view

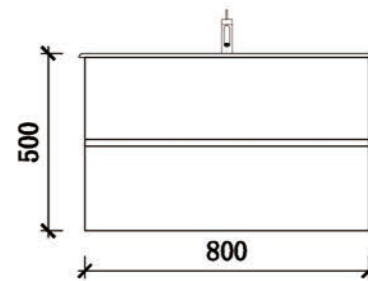
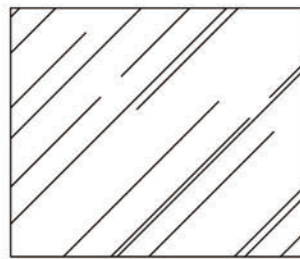

Front view

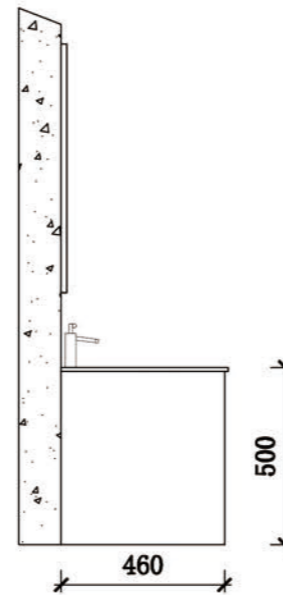

Side View

Product Installation

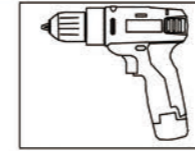

electric hand drill

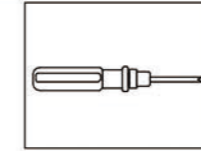

Straight screwdriver

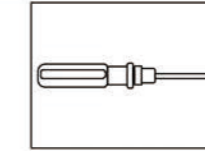

Cross screwdriver

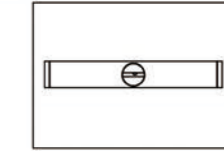

Horizontal rule

Step1: Determine good position of bathroom cabinet installation, put good main cabinet

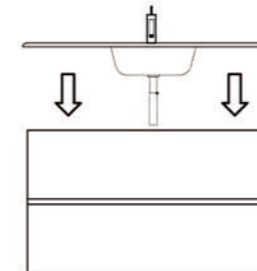
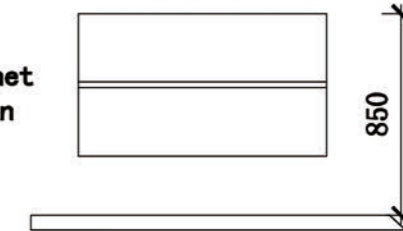

Step2: Install the faucet on the ceramic basin and place it on the main cabinet. Place the Faucet on the wall and fix it with glass glue



Step3: Install and measure the hole distance on the back of the mirror according to the position of the table basin

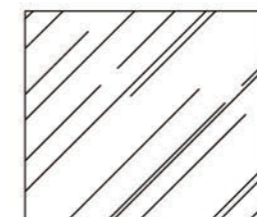
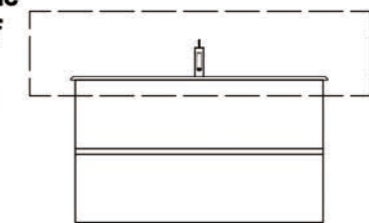

Step4: Fix the mirror. Set it up

